



GSA prices effective April 2, 2018  
(based on February 6, 2017, commercial price list)  
Published April 2018

## Multipurpose Seating Embody® Chairs

### General Services Administration Federal Supply Service Authorized Federal Supply Schedule Price List

Online access to contract ordering information, terms and conditions, up-to-date pricing, and the option to create an electronic delivery order is available through GSA Advantage!, a menu-driven database system. The Internet address for GSA Advantage! is [www.gsaadvantage.gov](http://www.gsaadvantage.gov).

Office Furniture  
FSC Group 71, Part 1  
Contract Number: GS-03F-036DA  
Contract Period: December 21, 2015—December 20, 2020

Herman Miller, Inc.  
855 East Main Avenue  
Zeeland, Michigan 49464  
(616) 654 3000 Phone  
(616) 654 8278 Fax  
[www.HermanMiller.com/government](http://www.HermanMiller.com/government)

Business Size: Large



# Contract Information

## 1a. Special Item Numbers (SIN)

SIN 71-1  
Packaged Offices

SIN 711-1  
Furniture Systems

SIN 711-2  
Computer Furniture

SIN 711-3  
Filing and Storage Cabinets

SIN 711-11  
Tables and Accessories

SIN 711-16  
Upholstered Seating

SIN 711-18  
Multi-Purpose Seating

SIN 711-91  
Project Management

Services under this SIN may be used only in conjunction with the purchase of new furniture. Please contact your local Herman Miller representative to discuss the available labor categories (listed below). The hourly rates listed are "Not To Exceed" or "NTE" values.

Furniture Project Manager: \$64.75 per hour  
Furniture Project Coordinator: \$49.00 per hour  
Build-Out Project Manager: \$80.00 per hour

SIN 711-93  
Reconfiguration and Relocation Services

Reconfiguration and Relocation Services will be provided by Herman Miller, Inc., or its participating dealer based on a fee not to exceed \$55 per hour, which applies to services totaling \$150,000 (per SIN) and below only. Services above \$150,000 shall be negotiated on a case-by-case basis. This SIN may only be used with the purchase of new product under SIN 711-1.

See \* Additional Notes for Installation & Reconfiguration and Relocation Services.

SIN 711-94  
Design/Layout

Design service will be provided by Herman Miller, Inc., or its participating dealer based on a fee not to exceed \$65 per hour.

SIN 711-95

Installation Services

Installation Services will be provided by Herman Miller, Inc., or its participating dealer based on a fee not to exceed \$55 per hour (\$82.50 per hour for after-hours Installation), which applies to services totaling \$150,000 (per SIN) and below only. Services above \$150,000 shall be negotiated on a case-by-case basis.

See \* Additional Notes for Installation & Reconfiguration and Relocation Services.

\* Additional Notes for Installation & Reconfiguration and Relocation Services:

FOB Destination (Drop Ship): Price includes product delivery to the site, brought to the tailgate of the truck. The purchaser is responsible for unloading.

Prices effective up to the maximum order by SIN only. Above the MO, pricing shall be negotiated on a case-by-case basis between the client and local dealer.

Standard Services are Subject to the Following Conditions:

Installation will be performed during normal weekday working hours.

Adequate facilities for delivery, unloading, moving and staging/ storing the product during the installation process shall be provided.

Service work will not be hindered by other trades.

Electric, heat, and adequate elevator service will be furnished without charge.

The immediate installation area shall be complete and free of debris including the carpet/flooring before installation commences.

Any work requiring a licensed electrician is the responsibility of the buyer.

Additional Charges May Apply For:

Major Metro Markets and any non-ground floor installation.

Major Metro Markets include large population centers and urban environments.

Installation in a clinical/medical environment.

Special restrictions or limits established by local laws, ordinances or the directions of the buyer, including but not limited to restrictions on transportations of materials, street access to the job site and/or dock facilities.

Installations outside of a 50 mile radius of the servicing dealer.

Local Prevailing Wage and/or Union Labor Rates.

Any additional charges shall be quoted by the dealer and approved by the buyer prior to performance of the work.

SIN 711-96

Leasing

Contact Herman Miller participating government dealer for current leasing information.

SIN 711-99

New Product Introductions

# Contract Information

continued

## 1b. Lowest Priced Model

SIN 711-1:	G9999.B	\$7
SIN 711-2:	6-5-D	\$35
SIN 711-3:	9M10018	\$14
SIN 711-11:	DT9A.	\$36
SIN 711-16:	OA401	\$41
SIN 711-18:	AS90598	\$46
SIN 711-99:	R1366	\$27

## 1c. Not applicable

## 2. Maximum Order

SIN 711-1, SIN 711-2  
\$500,000 net product value

SIN 711-3, SIN 711-11  
\$300,000 net product value

SIN 711-16, SIN 711-18  
\$200,000 net product value

SIN 711-93  
\$150,000

SIN 711-94  
\$150,000

SIN 711-95  
\$150,000

SIN 711-96  
\$500,000 net product value

SIN 711-99  
\$50,000 net product value

## 3. Minimum Order

\$100 net

## 4. Geographic Coverage

Continental U.S.

Orders for Alaska, Hawaii, and Puerto Rico will be shipped F.O.B. inland carrier point of exportation.

## 5. Point of Production

Zeeland, Ottawa County, Michigan  
Spring Lake, Ottawa County, Michigan

## 6. Pricing

Prices shown are list. Discounts include Industrial Funding Fee.

SIN 711-1

Product: Selected Action Office 1, Action Office 2, C-Style Overhead Storage, Ethospace System, Quadrant Pedestals, Supplemental Products, Tu Pedestals and Pedastools, and approved Herman Miller Options Products.

Standard Lead Time	Single Order Net Purchase	Discount From list
	\$100 - 250,000	73.8%
	\$250,001 - 500,000	76.8%

SIN 711-1

Product: Selected Renew™ Tables, Renew Link and approved Herman Miller Options Products

Standard Lead Time	Single Order Net Purchase	Discount From List
	\$100 - 500,000	72.8%

SIN 711-1

Product: Selected Motia™ Tables, and approved Herman Miller Options Products

Standard Lead Time	Single Order Net Purchase	Discount From List
	\$100 - 500,000	73.8%

SIN 711-1

Product: Tu Wood Pedestals and approved Herman Miller Options Products

Standard Lead Time	Single Order Net Purchase	Discount From List
	\$100 - 300,000	74.3%

SIN 711-1

Product: Selected Canvas Office Landscape and approved Herman Miller Options Products

Standard Lead Time	Single Order Net Purchase	Discount From List
	\$100 - 500,000	74.8%

SIN 711-1

Product: Selected Layout Studio® and approved Herman Miller Options Products

Standard Lead Time	Single Order Net Purchase	Discount From List
	\$100 - 500,000	60.7%

SIN 711-1

Product: Selected Meridian Pedestals, Meridian Pedastools, and approved Herman Miller Options Products

Standard Lead Time	Single Order Net Purchase	Discount From List
	\$100 - 500,000	64.2%

# Contract Information

continued

SIN 711-1

Product: Selected Thrive Portfolio and approved Herman Miller Options Products

Standard Lead Time	Single Order Net Purchase	Discount From List
	\$100 - 250,000	62%
	\$250,001 - 500,000	66.4%

SIN 711-2

Product: Passage Desking System and approved Herman Miller Options Products

Standard Lead Time	Single Order Net Purchase	Discount From List
	\$100 - 500,000	56.7%

SIN 711-2

Product: 5000 Series Furniture and approved Herman Miller Options Products

Standard Lead Time	Single Order Net Purchase	Discount From List
	\$100 - 500,000	58.7%

SIN 711-3

Product: Meridian Laterals, Verticals, Towers, and Storage products and approved Herman Miller Options Products

Standard Lead Time	Single Order Net Purchase	Discount From List Laterals	Verticals	Towers & Storage
	\$100 - 300,000	67.3%	66.3%	62.7%

SIN 711-3

Product: Tu Lateral Files, Tu Storage, Tu Towers, Tu Wood Cases, Tu Wood Cubbies, Tu Wood Credenzas, Tu Wood Towers, and approved Herman Miller Options Products

Standard Lead Time	Single Order Net Purchase	Discount From List
	\$100 - 300,000	74.3%

SIN 711-11

Product: Selected Tables and Accessories and approved Herman Miller Options Products

Standard Lead Time	Single Order Net Purchase	Discount From List
Avive® Tables	\$100 - 250,000	72.8%
	\$250,001 - 500,000	74.8%
Herman Miller Eames® Tables	\$100 - 250,000	73.6%
	\$250,001 - 300,000	77.6%
Everywhere™ Tables	\$100 - 300,000	72.8%

SIN 711-16

Product: Swoop upholstered seating products and approved Herman Miller Options Products

Standard Lead Time	Single Order Net Purchase	Discount From List
Swoop™	\$100 - 200,000	60.7%

SIN 711-18

Product: Selected Seating and approved Herman Miller Options Products

Standard Lead Time	Single Order Net Purchase	Discount From List
Aeron® (Classic and New)	\$100 - 200,000	64.5%
Aside®	\$100 - 200,000	64.2%
Caper®	\$100 - 200,000	61.5%
Celle®	\$100 - 200,000	59.7%
Embody®	\$100 - 200,000	59.7%
Equa 2®	\$100 - 200,000	65.8%
Ergon 3®	\$100 - 200,000	68.8%
Keyn	\$100 - 200,000	57.7%
Mirra® 2	\$100 - 200,000	61.7%
Setu®	\$100 - 200,000	59.7%
Sayl®	\$100 - 200,000	62.2%
Verus™	\$100 - 200,000	63.7%

SIN 711-99

Product: Selected Exclave™, Locale®, Public Office Landscape®, Resolve® System, and approved Herman Miller Options Products

Standard Lead Time	Single Order Net Purchase	Discount From List
Exclave	\$100 - 50,000	61.7%
Locale	\$100 - 50,000	63.7%
Public Office Landscape	\$100 - 50,000	61.7%
Resolve System	\$100 - 50,000	69.8%
Intent Solution	\$100 - 50,000	58.7%

## 7. Quantity Discounts

Reference item #6.

## 8. Payment Term

Net 30 days

## 9. Government Commercial Credit Card

- Government commercial credit cards are accepted below the micropurchase threshold.
- Government commercial credit cards are accepted above the micropurchase threshold.

## 10. Foreign Items

None

## 11. Time of Delivery

- 90 day ARO
- Expedited delivery: Items listed in the 10-Day section of the catalogs are available for expedited delivery.
- Overnight/2-day delivery: Select items may be available for overnight or 2-day delivery. Contact Herman Miller or a participating dealer for availability and rates.
- Urgent requirements: Agencies may contact contractor or participating dealer to request faster delivery.

# Contract Information

continued

## 12. F.O.B.

F.O.B. destination except Alaska, Hawaii, and Puerto Rico, which will be shipped F.O.B. inland carrier point of exportation.

## 13. Ordering Address

- a. Herman Miller, Inc.,  
Government Customer Care 0161  
855 East Main Avenue  
Zeeland MI 49464.
- b. For supplies and services, the ordering procedures information on Blanket Purchase Agreements (BPA's) and a sample BPA can be found at the GSA/FSS Schedule homepage ([www.fss.gsa.gov/schedules](http://www.fss.gsa.gov/schedules)).

## 14. Payment Address.

Herman Miller, Inc.  
22764 Network Place  
Chicago, IL 60673-1227

## 15. Warranty

Herman Miller, Inc., commercial warranty applies.

## 16. Export Packing Charge

Prices supplied on request.

## 17. Terms and Conditions of Government Purchase Card Acceptance

(any thresholds above the micropurchase level)  
None.

## 18. Rental Maintenance and Repair Terms

Not applicable

## 19. Terms and Conditions of Installation

Installation Services will be provided by Herman Miller, Inc., or its participating dealer based on a fee not to exceed \$55 per hour (\$82.50 per hour for after-hours Installation), which applies to services totaling \$150,000 (per SIN) and below only. Services above \$150,000 shall be negotiated on a case-by-case basis.

Additional Notes for Installation & Reconfiguration and Relocation Services:

FOB Destination (Drop Ship): Price includes product delivery to the site, brought to the tailgate of the truck. The purchaser is responsible for unloading.

Prices effective up to the maximum order by SIN only. Above the MO, pricing shall be negotiated on a case-by-case basis between the client and local dealer.

Standard Services are Subject to the Following Conditions:

Installation will be performed during normal weekday working hours.

Adequate facilities for delivery, unloading, moving and staging/storing the product during the installation process shall be provided.

Service work will not be hindered by other trades.

Electric, heat, and adequate elevator service will be furnished without charge.

The immediate installation area shall be complete and free of debris including the carpet/flooring before installation commences.

Any work requiring a licensed electrician is the responsibility of the buyer.

Additional Charges May Apply For:

Major Metro Markets and any non-ground floor installation.

Major Metro Markets include large population centers and urban environments.

Installation in a clinical/medical environment.

Special restrictions or limits established by local laws, ordinances or the directions of the buyer, including but not limited to restrictions on transportations of materials, street access to the job site and/or dock facilities.

Installations outside of a 50 mile radius of the servicing dealer.

Local Prevailing Wage and/or Union Labor Rates.

Any additional charges shall be quoted by the dealer and approved by the buyer prior to performance of the work.

## 20. Terms and Conditions of Repair Parts

Not applicable

## 21. Service and Distribution Points

For service and distribution points nearest you, call (800) 851 1196.

## 22. Participating Dealers

Access Herman Miller web site for current list of participating dealers: [www.HermanMiller.com/government](http://www.HermanMiller.com/government).

## 23. Preventive Maintenance

Not applicable

## 24a. Special Attributes.

2018

For the 11th consecutive year, Herman Miller received a perfect score on the Corporate Equality Index and we were designated as Best Place to Work for LGBT equality. This report evaluates U.S. companies in terms of diversity, particularly their LGBT-related policies and practices.

# Contract Information

*continued*

2017

Herman Miller was named the 2017 “Corporation of the Year” in the consumer products sector by the Michigan Minority Supplier Development Council (MMSDC).

Herman Miller has received a 2017 SEAL (Sustainability, Environmental Achievement and Leadership) Business Sustainability Award.

Herman Miller has earned the 4 Star Diversity Visionary Award. This award celebrates the diversity, equality, and inclusion work of Herman Miller. The award is presented at the annual Diversity Equity Inclusion Summit, held by the Grand Rapids Area Chamber of Commerce.

Herman Miller named one of the Best and Brightest in Wellness for the fifth year in a row.

Working Mother magazine has recognized Herman Miller as one of the 2017 Working Mother 100 Best Companies.

Herman Miller earned our tenth consecutive perfect score in Human Rights Campaign (HRC) Foundation’s 2017 Corporate Equality Index.

As one of the top-scoring companies in our industry for the thirteenth consecutive year, Herman Miller has qualified for inclusion in RobecoSAM’s 2017 Sustainability Yearbook and received the Bronze Class distinction for our excellent economic, environmental, and social sustainability performance.

Herman Miller has once again earned the WorldatWork Seal of Distinction, a unique standard of excellence in work-life effectiveness that shows we provide a distinct, mutually beneficial workplace experience.

2016

Herman Miller was recognized as the Business of the Year at the Annual Meeting of the West Michigan Environmental Action Council (WMEAC). This award goes to the business with the greatest depth and breadth of support, unwavering dedication to environmental action in West Michigan, and a strong corporate commitment to environmental advocacy.

The 101 Best and Brightest Sustainable Companies once again (fifth consecutive year) recognized Herman Miller as an organization in Michigan (and for the first time, in the nation) that exhibits leadership and innovation in its approach to sustainability.

Herman Miller has been recognized by the Michigan Minority Supplier Development Council (MMSDC), as a “Corporation of the Year”, and we also received a “2016 Excellence in Supplier Diversity Award” from the Great Lakes Women’s Business Council. Additionally, we are the only West Michigan company this year to receive an “Ambassadors Championing Excellence” Award from the MMSDC.

Plex Lounge Furniture from Herman Miller receives #MetropolisLikes award at NeoCon 2016.

Plex Lounge Furniture from Herman Miller receives Interior Design HiP Award for Workplace Seating/Lounge at NeoCon 2016.

Spot Stools from Herman Miller Collection receive Interior Design HiP Award for Hospitality Seating at NeoCon 2016.

Herman Miller has been named a 2020 Women on Boards Winning Company. Companies selected for this recognition are considered champions of board diversity as 20 percent or more of their board seats are occupied by women.

Herman Miller selected for inclusion in the 2016 RobecoSAM Sustainability Yearbook for twelfth consecutive year.

Herman Miller again earns the WorldatWork Work-Life 2016 Seal of Distinction. This award identifies organizations that focus on programs that promote work-life balance and overall well-being.

2015

Herman Miller earns ninth consecutive perfect score in Human Rights Campaign (HRC) Foundation’s 2016 Corporate Equality Index and we were designated as Best Place to Work for LGBT equality.

This is the fourth consecutive year that Herman Miller was named one of Michigan’s Best and Brightest Sustainable Companies.

Herman Miller has received the Best and Brightest in Wellness Award for the third year in a row. This program is an innovative initiative that recognizes and celebrates quality and excellence in health awareness.

Herman Miller received the Forest Stewardship Council (FSC) Leadership Award for longstanding commitment to manufacturing with wood sourced from responsibly managed forests, which reduces environmental impacts by protecting against deforestation and forest degradation.

Herman Miller accepted its second Excellence in Reusable Packaging Award from the Reusable Packaging Association.

Herman Miller has once again been recognized for its commitment to best-in-class economic, environmental, and societal sustainability, earning a spot on the prestigious Dow Jones Sustainability Index (DJSI) for the twelfth consecutive year. We are the only contract furniture company recognized globally for its corporate sustainability leadership.

Herman Miller selected for inclusion in the 2015 RobecoSAM Sustainability Yearbook; awarded Bronze Class distinction for excellent sustainability performance for the second consecutive year.

# Contract Information

*continued*

Herman Miller received a Michigan Business Pollution Prevention (MBP<sub>3</sub>) Certificate – a recognition given by the Michigan Department of Environmental Quality (MDEQ) to organizations committed to environmental stewardship, conservation, and sustainable operations. This basic partnership with the MDEQ, which we've maintained since 1998, makes us eligible for our Clean Corporate Citizen (CCC) status that began in 2004 and our Environmental Leader status, which we received for the first time this past year.

MedAssets named Herman Miller Healthcare as Platinum Suppliers. MedAssets, a large group purchasing organization, helps providers enhance operational and financial performance so they can sustainably serve the needs of their community.

Herman Miller honored with five of 20 spots for the Michigan Environmental Leaders Award by the Michigan Department of Environmental Quality for our outstanding, voluntary environmental stewardship.

Renew Sit-to-Stand tables recognized on Record Products 2014 list by Architectural Record.

Herman Miller was again awarded a perfect score in the 2015 Corporate Equality Index. This is the eighth consecutive year we received a perfect score.

2014

Herman Miller has received the Best and Brightest in Wellness Award for the second year in a row. This program is an innovative initiative that recognizes and celebrates quality and excellence in health awareness.

Herman Miller's Locale wins International Design Excellence Awards (IDEA) Gold in the Office & Productivity category.

Herman Miller achieves eleventh consecutive listing on Dow Jones Sustainability World Index, an international stock portfolio that evaluates the annual performance of the world's largest 2500 companies using economic, environmental, and social criteria, known as the "triple bottom line" of sustainability.

2013

Herman Miller achieves tenth consecutive listing on Dow Jones Sustainability World Index.

Herman Miller has received the Best and Brightest in Wellness Award. This program is an innovative initiative that recognizes and celebrates quality and excellence in health awareness.

Herman Miller Earns Perfect Score on the Corporate Equality Index. We are one of only 303 major U.S. businesses to receive a perfect score in 2013, an achievement we have now obtained seven years in a row.

Herman Miller is listed in Forbes Magazine inaugural "Platinum List" of America's 400 best managed, large companies.

For the second consecutive year, Herman Miller is honored as one of West Michigan's "101 Best and Brightest Sustainable Companies".

2012

Herman Miller accepted its first Excellence in Reusable Packaging Award from the Reusable Packaging Association.

Herman Miller is named "Corporation of the Year" in the commercial products sector by the Michigan Minority Supplier Development Council.

In July 2012 Herman Miller was inducted into the Made in the USA Hall of Fame. Herman Miller is one of only 20 companies across the nation to receive this distinction.

Herman Miller achieves ninth consecutive listing on Dow Jones Sustainability World Index.

Herman Miller is honored as one of West Michigan's 101 Best and Brightest Sustainable Companies.

The Sustainable Asset Management (SAM) group selected Herman Miller for inclusion in "The Sustainability Yearbook 2012" and has awarded Herman Miller both the "SAM Sector Leader" and "SAM Sector Mover" distinctions.

Herman Miller was named one of 16 Section Leaders on Climate Counts 2011-2012 Scorecard Report, making us the industry leader for Home and office Furnishings.

SGS International Certification Services, Inc., recognizes Herman Miller's manufacturing sites, Midwest Distribution Center, and Design Yard for initial certification to the OHSAS 18001 standard as well as re-certification to ISO 14001.

2011

Trust Across America, a company dedicated to unraveling the complexities of trustworthy business behavior, listed Herman Miller as one of their "Top Ten Most Trustworthy Companies in America 2011."

The U.S. Environmental Protection Agency (EPA) selected Herman Miller, as a WasteWise Gold Achievement—Climate Change winner.

Herman Miller achieves eighth consecutive listing on Dow Jones Sustainability World Index, an international stock portfolio that evaluates the annual performance of the world's largest 2500 companies using economic, environmental, and social criteria, known as the "triple bottom line" of sustainability.

The Michigan Minority Supplier Development Council (MMSDC) named Herman Miller as its "Corporation of the Year" in the commercial products sector. This was the fifth time Herman Miller has received this award since 2005.



# Contract Information

*continued*

Herman Miller accepted its third Neighborhood Environmental Partners (NEP) award from the Michigan Department of Natural Resources and Environment.

Herman Miller receives the Reader's Choice award from TreeHugger's Best of Green: Design and Architecture category for the SAYL chair.

Herman Miller earns Citibank's Global Environmental Vendor of the Year award.

The SAYL chair from Herman Miller was dubbed the "Product Design of the Year" from the 2010 International Design Awards (IDA) jury.

Herman Miller Healthcare's Compass system was awarded a 2011 Medical Design Excellence Award (MDEA) for its research-based design and ability to be used in a variety of healing spaces, while simultaneously improving the overall delivery of healthcare.

The Sustainable Asset Management (SAM) Group selected Herman Miller for inclusion in the "Sustainability Yearbook 2011" and awarded us both the "SAM Sector Leader" and "SAM Sector Mover" distinctions.

Herman Miller has received the top rating for a fourth consecutive year in the Human Rights Campaign (HRC) Foundation's eighth annual Corporate Equality Index. The "Best Places to Work for LGBT Equality" distinction is awarded to businesses that scored 100% on the HRC Foundation's 2011 Corporate Equality Index.

Herman Miller again tops contract furniture industry in FORTUNE's "Most Admired" Companies survey. For the 23rd time in 25 years.

2010

The NASDAQ OMX CRD Global Sustainability Index (QCRD) has included Herman Miller among their top 100 companies in the world.

Herman Miller achieves seventh consecutive listing on Dow Jones Sustainability World Index, an international stock portfolio that evaluates the annual performance of the world's largest 2500 companies using economic, environmental, and social criteria, known as the "triple bottom line" of sustainability. Herman Miller is one of approximately 300 companies worldwide and the only contract office furniture manufacturer, selected for this index.

Herman Miller has been recognized by Fast Company magazine as one of its 2010 Most Innovative Companies and among the more select Innovation All-Stars.

The U.S. Environmental Protection Agency's Office of Resource Conservation and Recovery has selected Herman Miller to receive the 2010 WasteWise Gold Achievement Award for Green Purchasing.

The Michigan Department of Natural Resources and Environment (MDNRE) has recognized Herman Miller's West Michigan manufacturing sites and Midwest Distribution Center as continuing Clean Corporate Citizens.

Herman Miller makes the U.S. Environmental Protection Agency's (EPA) list of the top fifty users of renewable electricity, of more than 1,200 organizations participating in the Green Power Partnership. This is the second consecutive time Herman Miller was recognized. Herman Miller was the only furniture manufacturer on the list.

Herman Miller accepted its second Neighborhood Environmental Partners (NEP) award from the Michigan Department of Natural Resources and Environment.

For the 22nd time in 24 years, Herman Miller was awarded the No. 1 industry ranking in a survey among the executives and board members of peer companies and independent industry analysts, as published in FORTUNE magazine's annual "Most Admired" companies feature.

The Michigan Department of Environmental Quality (MDEQ) recognizes Herman Miller's GreenHouse as one of Michigan's top environmental performers with a Clean Corporate Citizen (C3) longevity award. This recognizes that the GreenHouse has maintained its C3 designation for the past five years.

For the third year in a row, Herman Miller makes FORTUNE magazine's "100 Best Companies to Work For" list. Herman Miller is one of only three Michigan-based companies to make the list.

## **24b. Section 508 Compliance**

Not applicable

## **25. Data Universal Numbering System (DUNS): 00-601-2801**

## **26. Registered in System for Award Management (www.SAM.gov) Database**

## **27. Cancellation**

Prior to production, no cancellation charge will apply. After production, only actual cost incurred that the contractor can demonstrate if items are sold after 3 months.

## **28. Restocking Charges**

Agencies must notify the contractor for authorization prior to returning any items. The customer agency will be required to pay all packaging and return freight charges. A restocking fee of 50% for Systems Furniture and 35% for all other product lines will be charged for any returned items.

## **Herman Miller Miscellaneous Information:**

Federal ID Number: 38-0837640

Commercial and Government Entity Code (CAGE): 40636

Data Universal Numbering System (DUNS) 00-601-2801

Commercial Entity Code (CEC): 00702290J



---

<b>Introduction</b>	<b>page 2</b>
<b>Embody® Chairs</b>	<b>3</b>
Work Chair	5
<b>Appendices</b>	
20-Day or Less/Assigned Lead-Time Order Information	
Casters and Glides	
Proprietary Textiles Application Chart-Seating	
Proprietary Textile Colors-Seating	
<b>For the latest materials information, refer to the Materials pages on HermanMiller.com.</b>	

---

# Introduction

## A Note on the Organization of This Book

There are a few signals that will help you understand the organization of this book. Once you know them, you should be able to find your way around easily.

### Like a newspaper, this book is formatted with columns of text and illustrations that run vertically.

Information wraps from one column to the next and continues for as many pages as it needs to.

### Black bars are clues.

A black bar at the top of a page signals the start of information about a product.

This information is divided into two sections, each signaled by a black bar. Product Information includes a description, additional notes, and dimensional drawings. Specification Information, which always begins at the top of a column, includes a series of steps. Each step represents a decision you need to make in order to complete your product number. Steps must be followed sequentially. The number of pages needed to complete information on a product varies; some will be complete in one page; others may fill three or four pages. Just continue going through the steps until you run into the next product, signaled by the black bar at the top of the page.

Black tabs running along the outside edge of the page help you locate what section you are in or what section you want to go to. You can thumb forwards or backwards to find a section; tabs and text appear on both sides of the page.

The additional pages in the back of the book include the appendices and indices. They are signaled by a long black bar running along the outside edge of the page.

### The index is presented two ways.

The first index is in alphabetical order by product name. It can be helpful if you are new to the products and numbering scheme or if you are looking for a type of product, such as work chair or round table.

The second index is by product number. It lists, in alphanumeric order, the base product number, typically a five-digit number.

## General Information

This book is effective April 2, 2018, subject to change without notice. Products may be purchased from authorized Herman Miller dealers who will quote prices upon request. For more information about our products and services or to see a list of dealers, visit [www.HermanMiller.com](http://www.HermanMiller.com).

All prices are list prices. Additional services, such as planning services, design, storage, and installation, are not included and must be added to these prices when the additional services are requested.

Illustrations, specifications, and prices are based on the latest information at the time of publication. The right is reserved to make changes at any time without notice in prices, fabrics, finishes, materials, specifications, and models, and also to discontinue models and finishes.

Dimensions shown in the drawings are engineering drawing dimensions rounded up to the nearest  $\frac{1}{8}$ ". Product is shipped set up or knocked down. Products that include "Shipped knocked down" in the description require some assembly. If this statement does not appear in the description, the product is shipped assembled.

Service problems are normally handled by a Herman Miller authorized dealer. Where this cannot be accomplished on a local level, service problems should be referred to the Customer Care Representative for your region, Herman Miller, Inc., Zeeland, Michigan 49464.

### 20-Day or Less/Assigned Lead-Time Shipments

All products and options in this price book not designated by an Assigned Program icon  will ship in **20 business days or less** after being acknowledged by Herman Miller.

Products and options designated by an  are on the assigned lead-time program and may ship in 20 days, less than 20 days, or more than 20 days from order acknowledgement.

**Work Chair**



# Work Chair

CN112  
CN122  
CN132



## Product Information

### Description

This chair has a pixelated seat and back that is textile-covered on the chair's front side. This construction provides support and comfort by spontaneously conforming to the user's shape and postural movements, while simultaneously moving heat away from the body. The Instinctive Back design mimics the human spine, providing passive support to the sacral, lumbar, and thoracic regions of the user's back, while the frameless, narrow back shape allows freedom of movement through the arms, neck and shoulders. The seat depth adjusts from 15" to 18" in 6 locking positions. The tilt supports the thoracic spine and stabilizes the pelvis through the deep, balanced recline. The tilt limiter allows the user to limit the amount of recline. The chair has a 5-star base and low-, standard-, or extended-height range options. Arm choices include no arms or fully adjustable arms that adjust 6" vertically and 6" horizontally. Textile on chair's front side is replaceable.

### Notes

For chairs with 3014, 3512, or 3513 textile color and graphite (G1) frame finish, the back mat is graphite. For all other options, the back mat is translucent. Chair is tested and warranted for use by persons 300 pounds and under. For information on casters, see Casters and Glides in Appendices. Customer's Own Material (COM) and Customer's Own Leather (COL) are not available on this chair.

## Dimensions

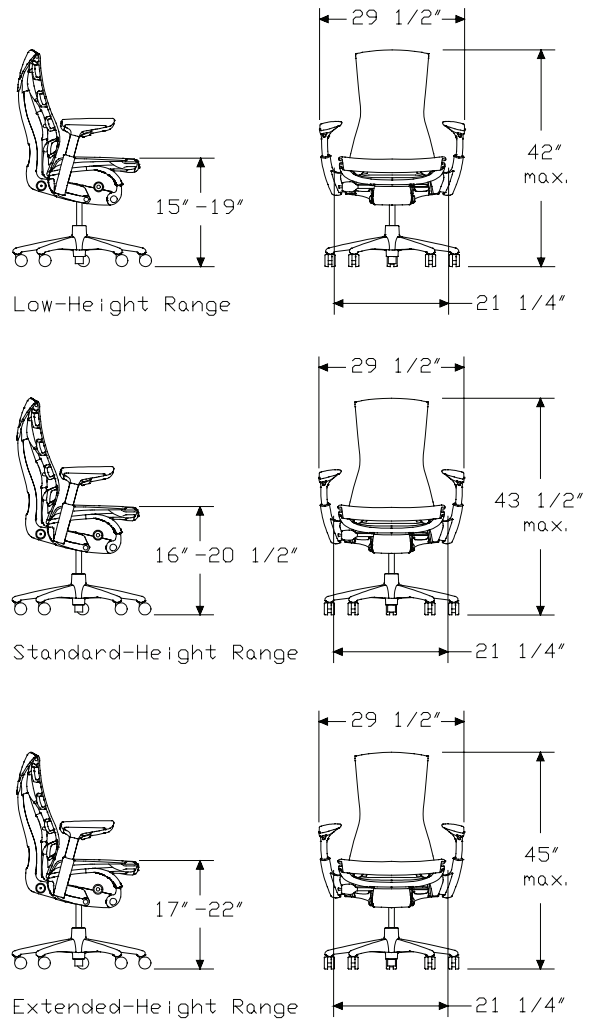

**Specification Information**

Step 1.

**CN1**

Step 2. Height Range

- 12** low-height range
- 22** standard-height range
- 32** extended-height range

Step 3. Arms

- NNAA** no arms
- AWAA** fully adjustable arms

Step 4. Fire Retardancy

*For not fire retardant (\*), skip this step.*  
not fire retardant

Prices for Steps 1-4.

	<b>*</b>
<b>CN112 NNAA</b>	\$1430
<b>AWAA</b>	\$1525
<b>CN122 NNAA</b>	\$1430
<b>AWAA</b>	\$1525
<b>CN132 NNAA</b>	\$1477
<b>AWAA</b>	\$1574

Step 5. Base Finish

- G1** graphite +\$0
- XT** titanium +\$0
- CD** polished aluminum +\$300

Step 6. Frame Finish

- G1** graphite +\$0
- 91** white +\$55

Step 7. Casters

- BB** 2 1/2" hard caster, black yoke, carpet only +\$0
- C7** 2 1/2" caster, black yoke, hard floors or carpet +\$40
- C9** 2 1/2" braking caster, black yoke, hard floors or carpet +\$40
- H9** 2 1/2" translucent caster, hard floors or carpet +\$50

Step 8. Fabric

*See application chart and textiles list for fabric usage and numbers. First 2 digits of number indicate fabric line; remaining digit(s) indicate fabric color.*



- Price Category 2 +\$0
- Price Category 4 +\$50
- Price Category 6 +\$240



## 20-Day or Less/Assigned Lead-Time Order Information

### 20-Day or Less and Assigned Lead-Time Programs

20-day or less and assigned lead-time products are designed for established Herman Miller dealers with pre-approved credit.

Products are distributed from multiple manufacturing facilities across the United States. All products and options not designated by an Assigned Lead-Time icon  will ship in 20 business days or less after being acknowledged by Herman Miller. Products and options designated by an  are on the assigned lead-time program and will ship in 20 days, less than 20 days, or more than 20 days from order acknowledgement.

### Ordering Procedure

Please place orders through Order Manager. If this is not available to you, place orders through mail or fax. Verbal purchase orders will not be accepted.

Order Entry fax number for Passage®, 5000 Series, and Meridian® Filing and Storage: (616) 846 9236.

Order Entry fax number for all other products:  
(616) 654 3085.

For more information, contact your Customer Care representative at:  
(866) 854 3048 EXT 3400.

### Shipments and Delivery

Per Herman Miller Terms and Conditions.

### Changes and Cancellation

Per Herman Miller Terms and Conditions.



# Casters and Glides

⚠	<b>WARNING</b>	⚠
Depending on the floor surface, chair may unexpectedly roll away from user when entering or exiting the chair, possibly leading to unexpected injury. Please refer to descriptions of floor types when selecting casters.		

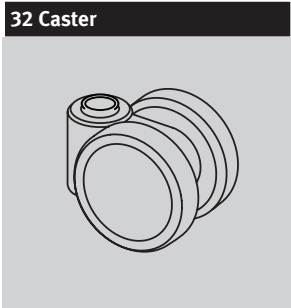

17/8-inch-diameter hard double-wheel caster; black nylon wheels and yoke; for use on carpet only  
 Applicable on:  
 Sayl® Chairs

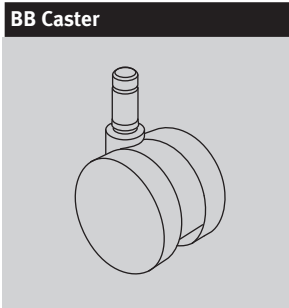

2 1/2-inch-diameter hard double-wheel caster; black nylon wheels and yoke; for use on carpet only  
 Applicable on:  
 New Aeron® Chairs  
 Classic Aeron Chairs  
 Caper® Chairs  
 Celle® Chairs  
 Embody® Chairs  
 Equa 2® Chairs  
 Ergon 3® Chairs  
 Mirra® 2 Chairs  
 Sayl Chairs

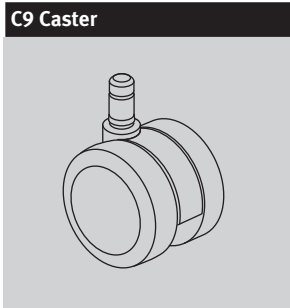

2 1/2-inch-diameter double-wheel caster; black nylon wheels and yoke; soft polyurethane tread; internal brake; for use on hard floors or carpet  
 Applicable on:  
 Classic Aeron Chairs  
 Caper Chairs  
 Celle Chairs  
 Embody Chairs  
 Equa 2 Chairs  
 Ergon 3 Chairs  
 Mirra 2 Chairs  
 Sayl Chairs  
 Setu® Stools Only

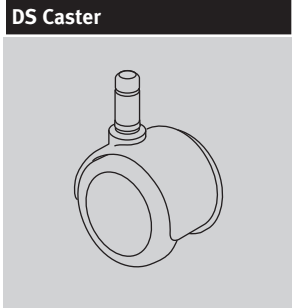

2-inch-diameter soft double-wheel braking caster; black nylon wheels and hood; for use on hard floors only  
 Applicable on:  
 Aside® Chairs  
 Caper Chairs

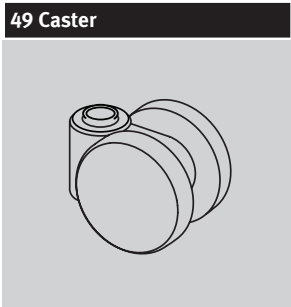

17/8-inch-diameter soft double-wheel caster; black nylon wheels and yoke; for use on hard floors or carpet  
 Applicable on:  
 Sayl Chairs

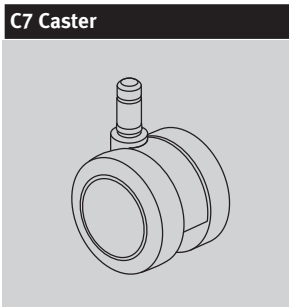

2 1/2-inch-diameter double-wheel caster; black nylon wheels and yoke; soft polyurethane tread; for use on hard floors or carpet  
 Applicable on:  
 New Aeron Chairs  
 Classic Aeron Chairs  
 Caper Chairs  
 Celle Chairs  
 Embody Chairs  
 Equa 2 Chairs  
 Ergon 3 Chairs  
 Mirra 2 Chairs  
 Sayl Chairs

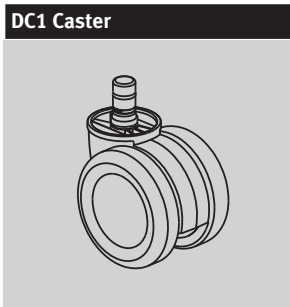

2 1/2-inch-diameter double-wheel braking caster; black nylon wheels and yoke; for use on hard floors or carpet; quiet roll technology  
 Applicable on:  
 New Aeron Chairs

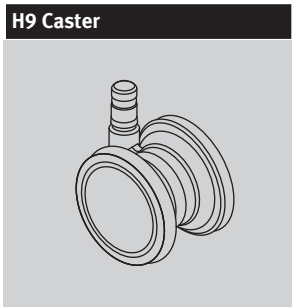

2 1/2-inch-diameter double-wheel caster; clear polycarbonate wheels; nylon yoke; soft polyurethane tread; for use on carpet only.  
 Applicable on:  
 Embody Chairs  
 Setu Chairs

# Casters and Glides

continued

**HCC Caster**

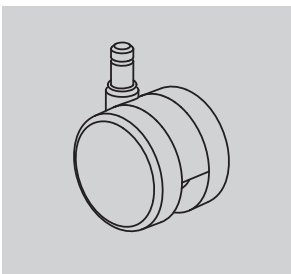

2 1/2-inch-diameter double-wheel medium roll resistance caster; black yoke; for use on hard floors or carpet.

Applicable on:  
Setu Chairs

**SC8 Caster**

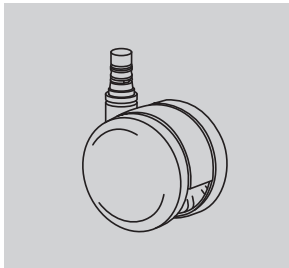

2 1/2-inch-diameter double-wheel caster; black nylon wheels and yoke; soft polyurethane tread; quiet roll technology; for use on hard floors or carpet

Applicable on:  
Mirra 2 Chairs

**U5 Caster**

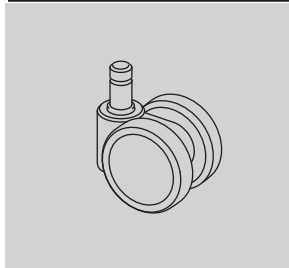

1 7/8-inch-diameter soft double-wheel caster; black nylon wheels and yoke; for use on hard floors or carpet

Applicable on:  
Aside Chairs  
Caper Chairs

**69 Glide**

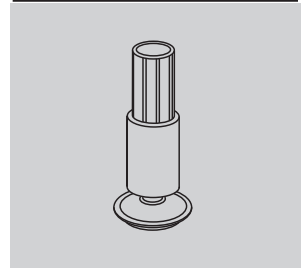

(Front glide shown)  
2 1/8-inch-high glide; black glass-filled nylon stem; steel-plated swivel foot with Floor Saver Glide® insert; for use on hard floors only

Applicable on:  
Sayl Chairs

**OC Caster**

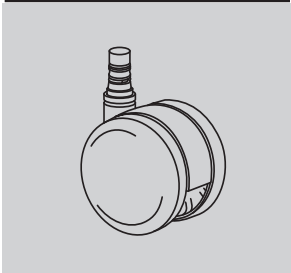

Setu-specific 2 1/2-inch-diameter double-wheel medium roll-resistant caster; black nylon wheels and yoke; soft polyurethane tread; for use on hard floors or carpet; quiet roll technology

Applicable on:  
Setu Chairs

**U4 Caster**

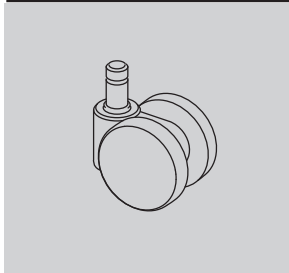

1 7/8-inch-diameter hard double-wheel caster; black nylon wheels and yoke; for use on carpet only

Applicable on:  
Aside Chairs  
Caper Chairs

**16 Glide**

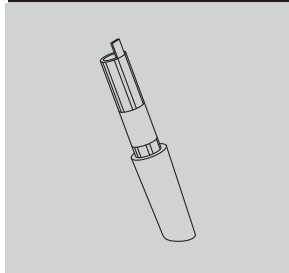

(Front glide shown)  
2 1/8-inch-high glide; black or fog acetate; for use on carpet only

Applicable on:  
Sayl Chairs

**GF Glide**

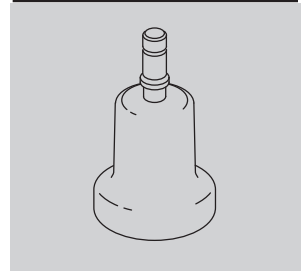

2 1/2-inch-high glide; black nylon; for use on hard floors or carpet

Applicable on:  
New Aeron Chairs  
Classic Aeron Chairs  
Caper Chairs  
Celle Chairs  
Equa 2 Chairs  
Ergon 3 Chairs  
Mirra 2 Chairs  
Sayl Chairs

# Casters and Glides

continued

## HG Glide



1/2-inch-high glide; black nylon glide with stainless-steel insert; for use on hard floors or carpet  
Applicable on:  
Aside Chairs

## SG Glide (for Aside)



1/2-inch-high glide; black nylon; for use on carpet only  
Applicable on:  
Aside Chairs

## XS Glide

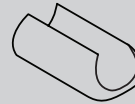

1/8-inch-high glide; polycarbonate in black, fog, clear, and studio white finishes; for use on hard floors or carpet  
Applicable on:  
Sayl Chairs

## YX Glide

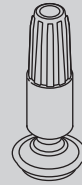

1 7/8-inch-high glide; black nylon stem; steel-plated swivel foot with Floor Saver Glide® insert; for use on hard floors only  
Applicable on:  
Caper Chairs

## SB Glide



1/4-inch-high, 1-inch diameter glide; thermoplastic CAP material (G1 base has black glides; XT base has clear glides); for use on hard floors or carpet  
Applicable on:  
Classic Aeron Chairs  
Equa 2 Chairs

## X8 Glide



Glide; low profile; for use on hard floors or carpet  
Applicable on:  
Setu Chairs

## Y7 Glide



1 7/8-inch-high glide; black acetal; for use on carpet only  
Applicable on:  
Caper Chairs



# Proprietary Textiles Application Chart — Seating

• Available

[A] Assigned lead-time textile.

See following page for exception notes.

[N] Non-woven textile.

	Aeron® Chairs	Mirra® 2 Chairs/Stools	Celle® Chairs	Embody® Chairs	Sayl® Work Chairs/Stools	Sayl Side Chairs	Setu® Chairs/Stools	Setu Lounge Chair/Ottoman	Verus™ Work Chairs/Stools Back	Verus Work Chairs/Stools Seat	Verus Side Chairs Back	Verus Side Chairs Seat	Ergon 3® Chairs	Equa 2 Fully Upholstered Chairs/Stools	Equa 2 Split-Pad Upholstered Chairs/Stools	Aside® Chairs	Caper® Chairs/Stools	Keyn Chair Group Back	Keyn Chair Group Seat	Locale® Bench Cushion	Public® Office Landscape Back	Public Office Landscape Seat	Swoop™ Lounge Seating - Fully Upholstered	Swoop Lounge Seating - Plywood	Cushion Tops	Workspaces
<b>Price Category 1</b>																										
COM Customer's Own Material [A]		14		1	1								1	1	1		1	1			1	1	1	1		
231__ 8Z Pellicle®	•																									
1A7__ AireWeave 2		•																								
3P__ ColorGuard [N]			15		21	22	•	•	•	•	•	•	2		3	8			•	•			•	•	•	•
8T__ Crossing			•				•	•					•	•	•	•				•			•	•	•	•
6V__ Flexnet™																	•									
95__ Gem			14				•	•					•	•	•	•				•			•	•	•	•
65__ Interweave									•		•															
4W__ Lyris 2™							•	•			•															
1MN__ Monologue			14		21	22	•	•		•	•	•	•						•	•		•	•	•		
3D__ Pellicle® Classic (3V__)																										
1WS__ Whisper			14		21		•	•	•	•	•	•	•	•	•	•			•	•		•	•	•		
<b>Price Category 2</b>																										
92__ Crepe			•		•	•	•	•	•	•	•	•	•	•	•	•		•	•	•			•	•	•	•
1LM__ Loom			14		•	•			•	•	•	•		•					•	•		•	•	•	•	•
1MV__ Marvel						21	•																		•	
1HA__ Medley			14		•	•	22		•	•	•	•	•	•	•	•		•	•	•	•	•	•	•	•	•
3A__ Moiré			14		•	•	•	•					•	•	•	•						•	•	•	•	•
30__ Rhythm			•	23	•				•	•	•	•			•	•			•	•	•	•	•	•	•	•
1RV__ Rivet			14						•	•	•	•							•	•		•	•	•	•	•
8R__ Twist			•		•	•	•	•	•	•	•	•			•	•			•	•		•	•	•	•	•
<b>Price Category 3</b>																										
70__ Bento					•	•	•	•		•	•	•	2	•	•	8			•							•
8M__ Latitude™			23		•	•									3								•	•		
8U__ Stitches					•	•	•	•	•	•	•	•			•	•			•	•		•	•	•	•	•
<b>Price Category 4</b>																										
7Y__ Bingo [N]							•	•	•	•	•	•	2		3	8			•	•						•
213__ Mercer			14		•	•	22			•	•	•							•			•	•	•	•	•
1A9__ Network																				•						
6J__ Plateau													•	•	•	•										•
6S__ Quilty			14		•	•			•	•	•	•							•	•			•	•		•
8Y__ Spools			14		21	•	•		•	•	•	•			•	•			•	•			•	•		•
22P__ Strata					21	22	•		•	•	•	•			•	•			•	•	•	•	•	•	•	•
<b>Price Category 5</b>																										
No fabrics available at this time																										
<b>Price Category 6</b>																										
35__ Balance					•		•																			
<b>Price Category 7</b>																										
COL Customer's Own Leather [A]	1	14											1	1	1	8									1	
<b>Price Category 8</b>																										
No fabrics available at this time																										
<b>Price Category 9</b>																										
21__ Leather	23	14												•	•	8								•	•	

# Proprietary Textiles Application Chart — Seating

continued

• Available

[A] Assigned lead-time textile.

See below for exception notes.

[N] Non-woven textile.

## Fire-Retardant Chairs/Fabrics

	Mirra® 2 Chairs/Stools with Butterfly Back™	Celle® Chairs	Embody® Chairs	Sayl® Work Chairs/Stools	Sayl Side Chairs	Setu® Chairs/Stools	Setu Lounge Chair/Ottoman	Ergon 3® Chairs	Equa 2® Fully Upholstered Chairs/Stools	Equa 2 Split-Pad Upholstered Chairs/Stools	Aside® Chairs	Caper® Chairs/Stools	Swoop™ Lounge Seating - Fully Upholstered
<b>Price Category 1</b>													
COM Customers Own Material [A]							1	1	1	1			
1A7__ AireWeave™ 2	•												
3P__ ColorGuard [N]		15	24	22			2		3	8			•
8T__ Crossing		14				•	•	•	•	•			•
6V__ Flexnet™												•	
95__ Gem		14				•	•	•	•	•			•
4W__ Lyris 2™					18	•							
<b>Price Category 2</b>													
92__ Crepe		14		•	•				•	•	•		•
3A__ Moiré		14		•	•	•	•	•	•	•			
30__ Rhythm		14	16	24	•						8		•
8R__ Twist		14		•	•	•	•	•		•	8		•
<b>Price Category 3</b>													
70__ Bento				•	•	•	•	2			8		•
8M__ Latitude™		•		•	•								
8U__ Stitches		14		•	•	•	•	•	•	•	•		•
<b>Price Category 4</b>													
6J__ Plateau											•		
6S__ QUILTY		14		•	•								•
<b>Price Category 5</b>													
No fabrics available at this time													
<b>Price Category 6</b>													
35__ BALANCE			17										
<b>Price Category 9</b>													
21__ Leather		14									8		

All foam and Proprietary Textiles on HermanMiller seating comply with California TB 117-2013.

Application Note: Herman Miller cannot guarantee material/pattern alignment in adjacent products. For example, a fabric's pattern may not align from one pedestal cushion top to the next, or from one chair to the next.

- 1 Refer to price book appendices and Kiosk for COM/COL information.
- 2 Available on all Ergon 3 chairs except for fabric back (FB) option.
- 3 Available on A-and B-size Equa 2 split-pad upholstered chairs.
- 5 Available on all Ambi chairs except for fabric back (FB) option.
- 8 Only available on non-upholstered outer back (PB) option.
- 14 Available on Celle UC (upholstered seat) chairs.
- 15 Available on Celle HC (upholstered seat with protective edge) Chairs.
- 16 Only available in 3014 Black.

- 17 Only available in 3512 Carbon and 3513 Black.
- 18 Only available in 4W31 Graphite.
- 21 Not available on Sayl upholstered back work chairs.
- 22 Not available on Sayl side chairs with upholstered backs.
- 23 Available in select colors. Refer to "Proprietary Textile Colors - Seating" for color offering.
- 24 Not available on Sayl upholstered High-Back Work Chairs.



# Proprietary Textile Colors — Seating

## Price Category 1

### Customer's Own Material

See Order Information in Appendices.  
Assigned lead-time textile. A

### 8Z Pellicle®

For New Aeron® Chairs  
56% elastomeric  
44% polyester

23101	Mineral
23102	Carbon
23103	Graphite

### AireWeave™ 2

For Mirra® 2 Chairs  
67% elastomeric  
33% antimony-free polyester

1A701	Alpine
1A702	Slate Grey
1A703	Graphite
1A704	Lime Green
1A705	Cappuccino
1A706	Urban Orange
1A707	Dark Turquoise
1A708	Twilight

### ColorGuard

54" wide	
100% vinyl	
3P01	Grey
3P02	Navy
3P03	Spruce <span style="border: 1px solid black; padding: 0 2px;">A</span>
3P08	Blueberry <span style="border: 1px solid black; padding: 0 2px;">A</span>
3P12	Black Plum <span style="border: 1px solid black; padding: 0 2px;">A</span>
3P14	Black
3P19	Slate
3P31	Horizon Blue <span style="border: 1px solid black; padding: 0 2px;">A</span>
3P33	Pumice
3P54	Candy Apple <span style="border: 1px solid black; padding: 0 2px;">A</span>
3P72	Allspice <span style="border: 1px solid black; padding: 0 2px;">A</span>
3P96	Manzanita <span style="border: 1px solid black; padding: 0 2px;">A</span>
3P97	Fudge <span style="border: 1px solid black; padding: 0 2px;">A</span>
3PB2	Sea Grass <span style="border: 1px solid black; padding: 0 2px;">A</span>
3PB5	Vizcaya Palm <span style="border: 1px solid black; padding: 0 2px;">A</span>
3PB9	Neptune <span style="border: 1px solid black; padding: 0 2px;">A</span>
3PC7	Bucksuede <span style="border: 1px solid black; padding: 0 2px;">A</span>
3PD4	Otter <span style="border: 1px solid black; padding: 0 2px;">A</span>

A Assigned lead-time color.

### Crossing

54" wide  
86% antimony-free polyester  
14% polyester

8T03	Wicker
8T04	Porcelain
8T05	Warm Grey
8T06	Sepia
8T07	Pumpkin
8T08	Copper
8T09	Cranberry
8T10	Tomato
8T11	Mulberry
8T12	Plum
8T13	Green Apple
8T14	Loden
8T15	Spruce
8T16	Periwinkle
8T17	Cerulean
8T18	Indigo
8T19	Shale
8T20	Brownstone
8T21	Bark
8T22	Tin
8T23	Graphite
8T24	Black

### Flexnet™

For Caper® Chairs  
69% elastomeric  
31% polyester

6V01	Black
6V02	Silver Grey

### Gem

54" wide  
100% antimony-free polyester

9501	Sesame
9502	Tangerine
9503	Red
9504	Red Violet
9505	Mulberry
9506	Java
9507	Twilight
9508	Bayou
9509	Iris
9510	Berry Blue
9511	Aqua Green
9512	Green Apple
9513	Spruce
9514	Black
9515	Slate Grey
9516	Fog

### Interweave

For Verus™ Chairs  
71% elastomeric  
29% polyester

6504	Pewter
6505	Charcoal
6506	Black

### Lyris 2™

For Setu® Chairs  
74% elastomeric  
26% polyester

4W21	Alpine
4W22	Mango
4W23	Chartreuse
4W25	Berry Blue
4W26	Slate Grey
4W28	Chino
4W29	Rattan
4W30	Java
4W31	Graphite

# Proprietary Textile Colors — Seating

continued

## Price Category 1

continued

### Monologue

54" wide	
56% recycled polyester	
44% polyester	
1MN01	Linen
1MN02	Alabaster
1MN03	Truffle
1MN04	Folkstone
1MN05	Silver Pine
1MN06	Slate
1MN07	Seed
1MN08	Yellow Oxide
1MN09	Persimmon
1MN10	Tundra
1MN11	Meadow
1MN12	Blue Sky
1MN13	Blue Spruce
1MN14	Deep Sea

### Whisper

54" wide	
73% recycled polyester	
27% polyester	
1WS01	Sand Dollar
1WS02	Pebble
1WS03	Silver Birch
1WS04	Iceberg
1WS05	Silver Pine
1WS06	Carbon
1WS07	Cumin
1WS08	Adobe
1WS09	Strawberry
1WS10	Blush
1WS11	Eggplant
1WS12	Willow
1WS13	Sea Grass
1WS14	Pool
1WS15	Blueberry

### Crepe

54" wide	
100% recycled polyester	
9201	Licorice
9203	Smoke
9207	Cherry
9209	Claret
9212	Raisin
9218	Aquamarine
9223	Cadet
9241	Beachglass
9243	Midnight
9244	Artichoke
9248	Warm White
9249	Stone
9250	Earth
9251	Fog
9252	Slate Grey
9253	Yellow Dark
9254	Coral
9255	Blush Grey
9256	Wild Berry
9257	Clover
9258	Caribbean
9259	Cerulean
9260	Brownstone
9261	Shale
9262	Graphite
9263	Tomato
9264	Green Apple

### Loom

54" wide	
100% polyester	
1LM01	Linen
1LM02	Brown Sugar and Spice
1LM03	Brick and Mortar
1LM04	Salt and Pepper
1LM05	Black
1LM06	Lemongrass
1LM07	Poppy
1LM08	Wild Berry
1LM09	Loden
1LM10	Jade
1LM11	Deep Sea

## Price Category 2

### Medley

54" wide	
100% polyester	
1HA01	Stone
1HA02	Trail
1HA03	Charcoal
1HA04	Cinder
1HA05	Citrus
1HA06	Papaya
1HA07	Chutney
1HA08	Tundra
1HA09	Feather Grey
1HA10	Chartreuse
1HA11	Loden
1HA12	Peacock
1HA13	Bayou
1HA14	Blue Grotto
1HA15	Blueberry
1HA22	Khaki
1HA23	Pewter
1HA24	Yellow Oxide
1HA25	Vintage Rose
1HA26	Raspberry
1HA27	Acai Berry

### Moiré

54" wide	
100% recycled polyester	
3A01	Concrete
3A02	Biscotti
3A03	Rattan
3A04	Chambray
3A05	Fern
3A08	Violet
3A09	Zin
3A10	Curry
3A11	Spice
3A12	Cork

### Rhythm

54" wide	
100% polyester	
3001	Kiwi Green *
3002	Green Apple
3003	Peacock
3004	Bayou *
3005	Berry Blue
3006	Iris
3007	Twilight
3008	Pumpkin *
3009	Poppy *
3010	Molasses
3011	Mulberry
3012	Khaki *
3013	Mink
3014	Black
3015	Charcoal

\* Colors not available on Embody Chair

### Rivet

54" wide	
100% recycled polyester	
1RV01	Twig
1RV02	Deep Clay
1RV03	Woodrose
1RV04	Otter
1RV05	Hemlock
1RV06	Olive
1RV07	Lagoon
1RV08	Deep Sea
1RV09	Charcoal
1RV10	Grey Brindle

Price category 2 continued on next page

# Proprietary Textile Colors — Seating

continued

## Price Category 2

continued

Twist	
54" wide	
80% antimony-free polyester	
13% recycled polyester	
7% polyester	
8R05	Wicker
8R10	Poppy
8R14	Tin
8R15	Shale
8R16	Graphite
8R17	Birch
8R18	Sepia
8R22	Blueberry
8R23	Green Apple
8R26	Gunmetal
8R27	Cinder
8R28	Citrus
8R29	Pekoe
8R30	Tangerine
8R31	Red Plum
8R32	Wisteria
8R33	Forest
8R34	Jade Dark
8R35	Waterfall
8R36	Midnight Blue
8R37	Carbon Dark

## Price Category 3

Bento	
54" wide	
100% antimony-free polyester	
7001	Frost
7002	Linen
7003	Khaki
7004	Truffle
7005	Grey Black
7006	Pumpkin
7007	Cranberry
7008	Everglade
7009	Cobalt

Latitude™	
61" wide	
100% polyester	
8M01	Graphite
8M02	Shadow
8M10	Alpine
8M17	Black
8M21	Slate Grey
8M22	Lime Green
8M23	French Press
8M24	Urban Orange
8M25	Dark Turquoise
8M26	Twilight

Stitches	
54" wide	
54% polyester	
46% recycled polyester	
8U02	Rye
8U03	Khaki
8U04	Honey
8U05	Cattail
8U08	Cool Grey
8U09	Slate Blue
8U11	Evening Blue
8U12	Charcoal
8U13	Kiwi Green
8U16	Cocoa
8U17	Seed

## Price Category 4

Bingo	
54" wide	
100% PVC-free polyurethane	
Resilience® finish	
7Y01	Oyster
7Y02	Natural
7Y03	Cashew
7Y05	Rattan
7Y06	Root
7Y07	Woodland
7Y10	Allspice
7Y11	Canyon
7Y17	Seed
7Y18	Mushroom
7Y19	Blue Grey
7Y21	Black
7Y22	Mint
7Y23	Seaport
7Y24	Evening Blue
7Y26	Kiwi Green
7Y27	Celadon
7Y29	Pesto

Mercer	
54" wide	
50% solution dyed recycled nylon	
50% solution dyed nylon	
BLOCKaide	
21301	Stone
21303	Cayenne
21305	Pesto
21306	Teal Blue
21307	Ultramarine
21310	Charcoal

Network	
For Public Office Landscape®	
sectional back/social chair.	
knit to size	
100% polyester	
1A901	Warm White
1A902	Fog
1A903	Red
1A904	Wildberry
1A905	Green Apple
1A906	Twilight
1A907	Graphite

Plateau	
knit to size	
100% polyester	
6J01	Feather Grey
6J02	Trail
6J06	Twig
6J08	Sagebrush
6J09	Winter Berry
6J10	Thunder
6J11	Blueberry
6J12	Rosemary
6J14	Black

Quilty	
56" wide	
100% antimony-free polyester	
GreenShield	
6S03	Khaki
6S04	Straw
6S07	Brick
6S10	Mink
6S11	Green Apple
6S13	Indigo
6S14	Zinc
6S15	Slate
6S16	Beachwood
6S17	Paprika
6S18	Plum
6S19	Juniper
6S20	Grey Black

Price category 4 continued on next page

# Proprietary Textile Colors — Seating

*continued*

## Price Category 4

*continued*

### Spools

54" wide  
 51% recycled polyester  
 49% polyester  
 Crypton® Green

8Y03	Trail
8Y05	Copper
8Y08	Bluegrass
8Y09	Lagoon
8Y11	Beachglass
8Y12	Marsh
8Y13	Bud

### Strata

54" wide  
 50% solution dyed recycled nylon  
 50% solution dyed nylon  
 BLOCKaide

22P04	Pesto
22P05	Peacock
22P06	Blue Jay
22P07	Blueberry
22P09	Mango
22P10	Paprika
22P12	Wheat
22P13	Brownstone
22P14	Bayou

## Price Category 5

No fabrics available at this time.

## Price Category 6

### Balance

100% polyester	
3506	Green Apple
3507	Blue Moon
3509	Berry Blue
3510	Iris
3512	Carbon
3513	Black

## Price Category 7

### Customer's Own Leather

See Order Information in Appendices. Assigned lead-time textile. [A](#)

# Proprietary Textile Colors — Seating

continued

---

## Price Category 8

No fabrics available at this time.

---

## Price Category 9

### Leather

approx. 50 sq. ft. per hide  
100% leather

2101	Ivory
2109	Black *
2110	Smoke
2111	Graphite
2112	Khaki
2113	Rattan
2114	Truffle
2115	Alpine
2116	Haze
2117	Sable Grey
2118	Dark Mineral **
2119	Dark Carbon ***
2120	Cranberry
2121	Deep Sea

\* Armpad color available on Aeron® Chair, Graphite.

\*\* Armpad color available on Aeron Chair, Mineral.

\*\*\* Armpad color available on Aeron Chair, Carbon.

For more information about our products and services or to see a list of dealers, please visit us at [HermanMiller.com](http://HermanMiller.com) or call (800) 851 1196.

© 2018 Herman Miller, Inc., Zeeland, Michigan

® **HermanMiller**, ●, Action Office, Aeron, Aside, Avive, Canvas Office Landscape, Caper, Celle, Co/Struc, Eames, Embody, Equa 2, Ergon 3, Ethospace, Exclave, Fine-Tune, FlexFront, Formcoat, Ground Cloth, Herman Miller Healthcare, Layout Studio, Maharam, Meridian, Mirra, Passage, Pellicle, Perspectives, PostureFit, Resolve, Sayl, Setu, Thrive, Tu, Y-Tower, and Z-Axis are among the registered trademarks of Herman Miller, Inc., and its owned subsidiaries.

™ AireWeave, Bubbletack, Cellular Suspension, Compass, Connect, DOT, Durawrap, Everywhere, Flex-Edge, Hopsak 2, Intent, Iota, Keyless Entry, Latitude, Lyris 2, Motia, Multiscrim, Nelson, Renew, Stackable, Swoop, TriFlex, Twist, and Verus are among the trademarks of Herman Miller, Inc., and its owned subsidiaries.

®Chemsurf® is a registered trademark of Wilsonart International.

Corian® is a registered trademark of E.I. du Pont de Nemours and Company Corporation.

FLEXNET™ is a trademark of Milliken & Company.

Floor Saver Glide® is a registered trademark of Carpin Manufacturing, Inc.

Geiger® is a registered trademark of Geiger International.

Microsoft® and Natural® Keyboard are registered trademarks of Microsoft Corporation.

Place Textiles® is a registered trademark of Place Textiles.